

UHF Narrow band radio data module

CDP-RX-02F 434 MHz



Operation Guide

Version 1.0 (June 2020)

- This product requires electrical and radio knowledge for setup and operation.
- To ensure proper and safe operation, please read this operation guide thoroughly prior to use.
- Please keep this operation guide for future reference.

CIRCUIT DESIGN, INC.

7557-1 Hotaka, Azumino
Nagano 399-8303 JAPAN
Tel: + +81-(0)263-82-1024
Fax: + +81-(0)263-82-1016

e-mail: info@circuitdesign.jp
<https://www.circuitdesign.jp>

CONTENTS

General description & Features.....	3
Specifications.....	4
Pin description	5
Channel and frequency settings.....	6
Tips for effective use of the reception performance.....	9
Block diagram	10
Dimensions	11
Test data	12
Regulatory compliance information	13
Important notice	14
Cautions.....	14
Warnings	14

General description & Features

General description

The CDP-RX-02F is narrowband FM radio receiver module suitable for various industrial application fields such as wireless data communication, remote control, telemetry or wireless security systems. It is easy to use and integrate into application systems.

The module is equipped with a frequency synthesizer system with micro controller. The available frequency range is from 433.1875 MHz to 434.7750 MHz (128 channels).

The CDP-RX-02F receiver has excellent blocking characteristics and adjacent channel selectivity to meet the requirement of EN 300 220 Receiver category 1.

Features

- Pre-programmed 128 ch in 434 MHz band (12.5 kHz step)
- Wide operating temperature range (-20 to +60 degree C)
- Narrow band FM 25 kHz channel spacing
- Receiver sensitivity -120 dBm - operating distance 600 m (when combined with CDP-TX-02F)
- High receiver performance of EN 300 220 category 1
- RED and RoHS compliant

Applications

- Radio remote control cranes and machines
- Factory automation M2M
- Security systems
- Alarms
- Telemetry systems

Specifications

All ratings at 25°C +/- 5°C unless otherwise noted

Parameter	Rating	Conditions
General characteristics		
Applicable standard	EN 300 220	Receiver category 1
Communication method	One way	
Operating frequency range	433.1875 – 434.7750 MHz	
Operating temperature range	-20 to + 60 °C	No dew condensation
Storage temperature range	-30 to + 70 °C	No dew condensation
Aging rate	Max. +/- 1 ppm / year	RX Local Freq.
Initial freq. tolerance	Max. +/- 2 ppm	At delivery *1
Dimension	30 x 50 x 9 mm	Excluding protrusion
Weight	20 g	Not including the antenna
Electrical specification		
Oscillation system	PLL controlled VCO	
Channel spacing	25 kHz	
Number of RF channels	128 channels (12.5 kHz step)	Default channel at delivery (434.775 MHz)
Data rate	300 to 4800 bps	(Pulse length Min. 208 us Max. 20 ms)
Data output level	L = Gnd H = Vcc	
Data polarity	Positive	TX DI vs RX DO
PLL reference frequency	21.25 MHz	TCXO
Antenna impedance	50 ohm	Nominal
Operating voltage	3 – 12 V	
Consumption current	Typ. 30 mA at 3 V	
	Typ. 33 mA at 12 V	
Receiver electrical specification		
Receiver type	Double superheterodyne PLL synthesizer	
Bit error rate (0 error /2556 bits)	Typ. -116 dBm	At DO 4800 bps PN9 (-20°C to + 60°C)
Bit error rate (1% bit error)	Typ. -120 dBm	At DO 4800 bps PN9 (-20°C to + 60°C)
Sensitivity (12 dB / SINAD)	Typ. -120 dBm	At AF fm1kHz, Dev.+/-2.0kHz, CCITT filter (-20 to + 60°C)
Frequency stability	Max. +/- 4 ppm	- 20 to 60°C with reference frequency at 25°C
Blocking *2	-20 dBm	
Spurious response rejection *2	-44 dBm	1st Mix, 2nd Mix
Adjacent channel selectivity *2	-50 dBm	+/- 25 kHz
Adjacent channel saturation *2	-20 dBm	+/- 25 kHz
Spurious radiation *2	- 60 dBm	Below 1 GHz
	- 50 dBm	Above 1 GHz
Distortion	- 26 dB	1 kHz Dev = +/-2.0 kHz CCITT filter (RF level -30 dBm)
S/N ratio	35 dB	1 kHz Dev = +/-2.0 kHz CCITT filter (RF level -30 dBm)
RSSI	230 mV +/- 50 mV	At -113 dBm
AF output level	145 mV +/- 30 mV	fmod = +/-2.0 kHz fm = 1.2 kHz (RF level -30 dBm)
	130 mV +/- 30 mV	fmod = +/-2.0 kHz fm = 2.4 kHz (RF level -30 dBm)
RSSI rising time	Typ. 20 ms / Max. 50 ms	Channel change (50 kHz) (-20°C to + 60°C)
	Typ. 40 ms / Max. 70 ms	At power on (-20°C to + 60°C)
Time to valid Data out *3	Typ. 50 ms / Max. 100 ms	Channel change (50 kHz) (-20°C to + 60°C)
	Typ. 70 ms / Max. 140 ms	At power on (-20°C to + 60°C)

Specifications are subject to change without prior notice

*1 Initial frequency tolerance is defined as frequency drift within 1 year after the final adjustment

*2 The measurement procedures are according to the ETSI EN 300 220.

*3 The valid output signal is determined at the point where the Bit Error Rate meter starts detecting a 4800 bps, 1010 repeated signal. The valid output signal varies with the temperature conditions. You must conduct field testing to verify the waiting time for a valid output signal in the user system.

Pin description

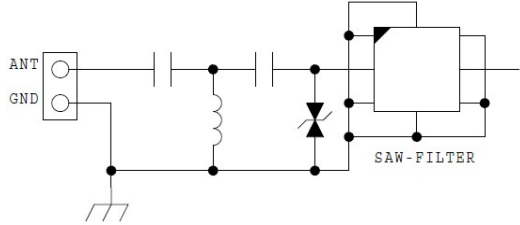
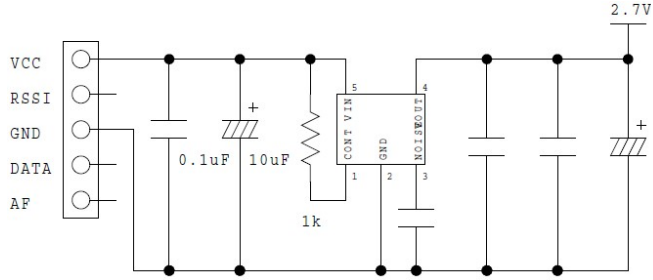
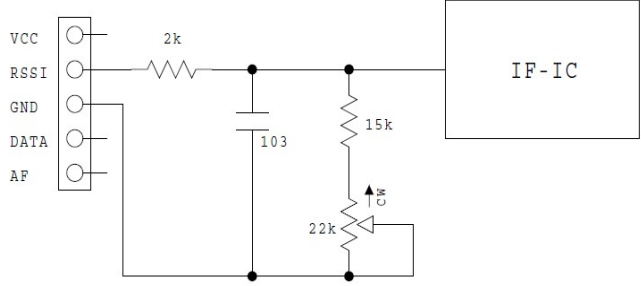
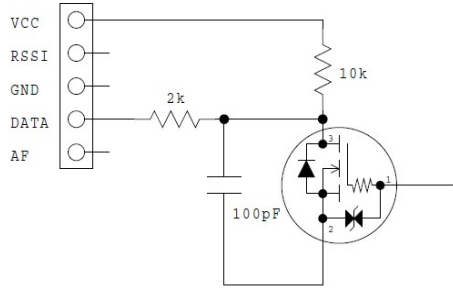
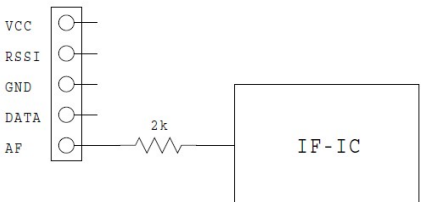
Pin name	I/O	Description	Equivalent circuit
ANT	I	RF input terminal Connect an antenna of 50 Ω impedance. Note that the antenna performance significantly changes depending on the connection condition, shape, and surrounding environment, and may affect the reception sensitivity and operation distance.	
GND	I	The ground for the power supply. Connect it to the ground plane as well as to the bottom part of the case. The ground plane has an impact on the range and the stability of operation.	
VCC	I	The power supply terminal. The supply voltage is DC 3.0 to 12 V. Power supply noise and ripple have an impact on performance, so eliminate them as far as possible with filters and capacitors.	
RSSI	O	The receive level output of the receiver. The strength of the RF level (electric field intensity) is output as a direct-current voltage.	
DATA	O	Digital data output terminal Interface voltage: H = Vcc L = GND	
AF	O	The demodulated output of the receiver. The DC offset is about 1 V. Refer to the specifications for the amplitude level.	

Channel and frequency settings

By using a chip mounted 7-bit switch, you can select easily between the 128 channels. Before shipment all the modules are set to 434.775 MHz

Ch	Freq. (MHz)	7-bit Switch						
		1	2	3	4	5	6	7
0	433.1875	ON	ON	ON	ON	ON	ON	ON
1	433.2000	OFF	ON	ON	ON	ON	ON	ON
2	433.2125	ON	OFF	ON	ON	ON	ON	ON
3	433.2250	OFF	OFF	ON	ON	ON	ON	ON
4	433.2375	ON	ON	OFF	ON	ON	ON	ON
5	433.2500	OFF	ON	OFF	ON	ON	ON	ON
6	433.2625	ON	OFF	OFF	ON	ON	ON	ON
7	433.2750	OFF	OFF	OFF	ON	ON	ON	ON
8	433.2875	ON	ON	ON	OFF	ON	ON	ON
9	433.3000	OFF	ON	ON	OFF	ON	ON	ON
10	433.3125	ON	OFF	ON	OFF	ON	ON	ON
11	433.3250	OFF	OFF	ON	OFF	ON	ON	ON
12	433.3375	ON	ON	OFF	OFF	ON	ON	ON
13	433.3500	OFF	ON	OFF	OFF	ON	ON	ON
14	433.3625	ON	OFF	OFF	OFF	ON	ON	ON
15	433.3750	OFF	OFF	OFF	OFF	ON	ON	ON
16	433.3875	ON	ON	ON	ON	OFF	ON	ON
17	433.4000	OFF	ON	ON	ON	OFF	ON	ON
18	433.4125	ON	OFF	ON	ON	OFF	ON	ON
19	433.4250	OFF	OFF	ON	ON	OFF	ON	ON
20	433.4375	ON	ON	OFF	ON	OFF	ON	ON
21	433.4500	OFF	ON	OFF	ON	OFF	ON	ON
22	433.4625	ON	OFF	OFF	ON	OFF	ON	ON
23	433.4750	OFF	OFF	OFF	ON	OFF	ON	ON
24	433.4875	ON	ON	ON	OFF	OFF	ON	ON
25	433.5000	OFF	ON	ON	OFF	OFF	ON	ON
26	433.5125	ON	OFF	ON	OFF	OFF	ON	ON
27	433.5250	OFF	OFF	ON	OFF	OFF	ON	ON
28	433.5375	ON	ON	OFF	OFF	OFF	ON	ON
29	433.5500	OFF	ON	OFF	OFF	OFF	ON	ON
30	433.5625	ON	OFF	OFF	OFF	OFF	ON	ON
31	433.5750	OFF	OFF	OFF	OFF	OFF	ON	ON
32	433.5875	ON	ON	ON	ON	ON	OFF	ON
33	433.6000	OFF	ON	ON	ON	ON	OFF	ON
34	433.6125	ON	OFF	ON	ON	ON	OFF	ON
35	433.6250	OFF	OFF	ON	ON	ON	OFF	ON
36	433.6375	ON	ON	OFF	ON	ON	OFF	ON
37	433.6500	OFF	ON	OFF	ON	ON	OFF	ON
38	433.6625	ON	OFF	OFF	ON	ON	OFF	ON
39	433.6750	OFF	OFF	OFF	ON	ON	OFF	ON
40	433.6875	ON	ON	ON	OFF	ON	OFF	ON
41	433.7000	OFF	ON	ON	OFF	ON	OFF	ON
42	433.7125	ON	OFF	ON	OFF	ON	OFF	ON
43	433.7250	OFF	OFF	ON	OFF	ON	OFF	ON
44	433.7375	ON	ON	OFF	OFF	ON	OFF	ON
45	433.7500	OFF	ON	OFF	OFF	ON	OFF	ON

Ch	Freq. (MHz)	7-bit Switch						
		1	2	3	4	5	6	7
46	433.7625	ON	OFF	OFF	OFF	ON	OFF	ON
47	433.7750	OFF	OFF	OFF	OFF	ON	OFF	ON
48	433.7875	ON	ON	ON	ON	OFF	OFF	ON
49	433.8000	OFF	ON	ON	ON	OFF	OFF	ON
50	433.8125	ON	OFF	ON	ON	OFF	OFF	ON
51	433.8250	OFF	OFF	ON	ON	OFF	OFF	ON
52	433.8375	ON	ON	OFF	ON	OFF	OFF	ON
53	433.8500	OFF	ON	OFF	ON	OFF	OFF	ON
54	433.8625	ON	OFF	OFF	ON	OFF	OFF	ON
55	433.8750	OFF	OFF	OFF	ON	OFF	OFF	ON
56	433.8875	ON	ON	ON	OFF	OFF	OFF	ON
57	433.9000	OFF	ON	ON	OFF	OFF	OFF	ON
58	433.9125	ON	OFF	ON	OFF	OFF	OFF	ON
59	433.9250	OFF	OFF	ON	OFF	OFF	OFF	ON
60	433.9375	ON	ON	OFF	OFF	OFF	OFF	ON
61	433.9500	OFF	ON	OFF	OFF	OFF	OFF	ON
62	433.9625	ON	OFF	OFF	OFF	OFF	OFF	ON
63	433.9750	OFF	OFF	OFF	OFF	OFF	OFF	ON
64	433.9875	ON	ON	ON	ON	ON	ON	OFF
65	434.0000	OFF	ON	ON	ON	ON	ON	OFF
66	434.0125	ON	OFF	ON	ON	ON	ON	OFF
67	434.0250	OFF	OFF	ON	ON	ON	ON	OFF
68	434.0375	ON	ON	OFF	ON	ON	ON	OFF
69	434.0500	OFF	ON	OFF	ON	ON	ON	OFF
70	434.0625	ON	OFF	OFF	ON	ON	ON	OFF
71	434.0750	OFF	OFF	OFF	ON	ON	ON	OFF
72	434.0875	ON	ON	ON	OFF	ON	ON	OFF
73	434.1000	OFF	ON	ON	OFF	ON	ON	OFF
74	434.1125	ON	OFF	ON	OFF	ON	ON	OFF
75	434.1250	OFF	OFF	ON	OFF	ON	ON	OFF
76	434.1375	ON	ON	OFF	OFF	ON	ON	OFF
77	434.1500	OFF	ON	OFF	OFF	ON	ON	OFF
78	434.1625	ON	OFF	OFF	OFF	ON	ON	OFF
79	434.1750	OFF	OFF	OFF	OFF	ON	ON	OFF
80	434.1875	ON	ON	ON	ON	OFF	ON	OFF
81	434.2000	OFF	ON	ON	ON	OFF	ON	OFF
82	434.2125	ON	OFF	ON	ON	OFF	ON	OFF
83	434.2250	OFF	OFF	ON	ON	OFF	ON	OFF
84	434.2375	ON	ON	OFF	ON	OFF	ON	OFF
85	434.2500	OFF	ON	OFF	ON	OFF	ON	OFF
86	434.2625	ON	OFF	OFF	ON	OFF	ON	OFF
87	434.2750	OFF	OFF	OFF	ON	OFF	ON	OFF
88	434.2875	ON	ON	ON	OFF	OFF	ON	OFF
89	434.3000	OFF	ON	ON	OFF	OFF	ON	OFF
90	434.3125	ON	OFF	ON	OFF	OFF	ON	OFF
91	434.3250	OFF	OFF	ON	OFF	OFF	ON	OFF
92	434.3375	ON	ON	OFF	OFF	OFF	ON	OFF
93	434.3500	OFF	ON	OFF	OFF	OFF	ON	OFF
94	434.3625	ON	OFF	OFF	OFF	OFF	ON	OFF
95	434.3750	OFF	OFF	OFF	OFF	OFF	ON	OFF

Ch	Freq. (MHz)	7-bit Switch						
		1	2	3	4	5	6	7
96	434.3875	ON	ON	ON	ON	ON	OFF	OFF
97	434.4000	OFF	ON	ON	ON	ON	OFF	OFF
98	434.4125	ON	OFF	ON	ON	ON	OFF	OFF
99	434.4250	OFF	OFF	ON	ON	ON	OFF	OFF
100	434.4375	ON	ON	OFF	ON	ON	OFF	OFF
101	434.4500	OFF	ON	OFF	ON	ON	OFF	OFF
102	434.4625	ON	OFF	OFF	ON	ON	OFF	OFF
103	434.4750	OFF	OFF	OFF	ON	ON	OFF	OFF
104	434.4875	ON	ON	ON	OFF	ON	OFF	OFF
105	434.5000	OFF	ON	ON	OFF	ON	OFF	OFF
106	434.5125	ON	OFF	ON	OFF	ON	OFF	OFF
107	434.5250	OFF	OFF	ON	OFF	ON	OFF	OFF
108	434.5375	ON	ON	OFF	OFF	ON	OFF	OFF
109	434.5500	OFF	ON	OFF	OFF	ON	OFF	OFF
110	434.5625	ON	OFF	OFF	OFF	ON	OFF	OFF
111	434.5750	OFF	OFF	OFF	OFF	ON	OFF	OFF
112	434.5875	ON	ON	ON	ON	OFF	OFF	OFF
113	434.6000	OFF	ON	ON	ON	OFF	OFF	OFF
114	434.6125	ON	OFF	ON	ON	OFF	OFF	OFF
115	434.6250	OFF	OFF	ON	ON	OFF	OFF	OFF
116	434.6375	ON	ON	OFF	ON	OFF	OFF	OFF
117	434.6500	OFF	ON	OFF	ON	OFF	OFF	OFF
118	434.6625	ON	OFF	OFF	ON	OFF	OFF	OFF
119	434.6750	OFF	OFF	OFF	ON	OFF	OFF	OFF
120	434.6875	ON	ON	ON	OFF	OFF	OFF	OFF
121	434.7000	OFF	ON	ON	OFF	OFF	OFF	OFF
122	434.7125	ON	OFF	ON	OFF	OFF	OFF	OFF
123	434.7250	OFF	OFF	ON	OFF	OFF	OFF	OFF
124	434.7375	ON	ON	OFF	OFF	OFF	OFF	OFF
125	434.7500	OFF	ON	OFF	OFF	OFF	OFF	OFF
126	434.7625	ON	OFF	OFF	OFF	OFF	OFF	OFF
127	434.7750	OFF	OFF	OFF	OFF	OFF	OFF	OFF

* Channel No. 127 : Default setting

* 7 bit switch: ON = L (GND) OFF = H (Open)

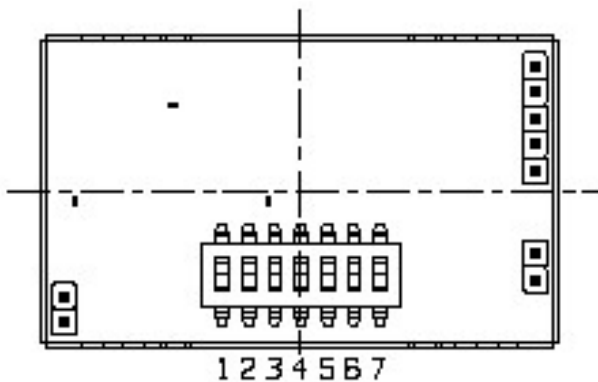

Tips for effective use of the receiver performance

The CDP-RX-02F is designed for high sensitivity to obtain radio signals over long distances. On the other hand, it may be sensitive to noise from the microcomputer and surrounding digital circuits due to its high sensitivity.

For stable operation, it is recommended to solder the shield case to as wide a ground pattern as possible.



● Soldering point

The module is also designed to be vibration resistant. However there is a limit to the amount of shock and vibration it can sustain due to its construction.

When using the module in the application where vibration is always present, use a shock absorber or fix the PCB at the vicinity of the four corners of the receiver module in addition to fixing the four corners of the PCB on which the radio module is mounted.

Block diagram

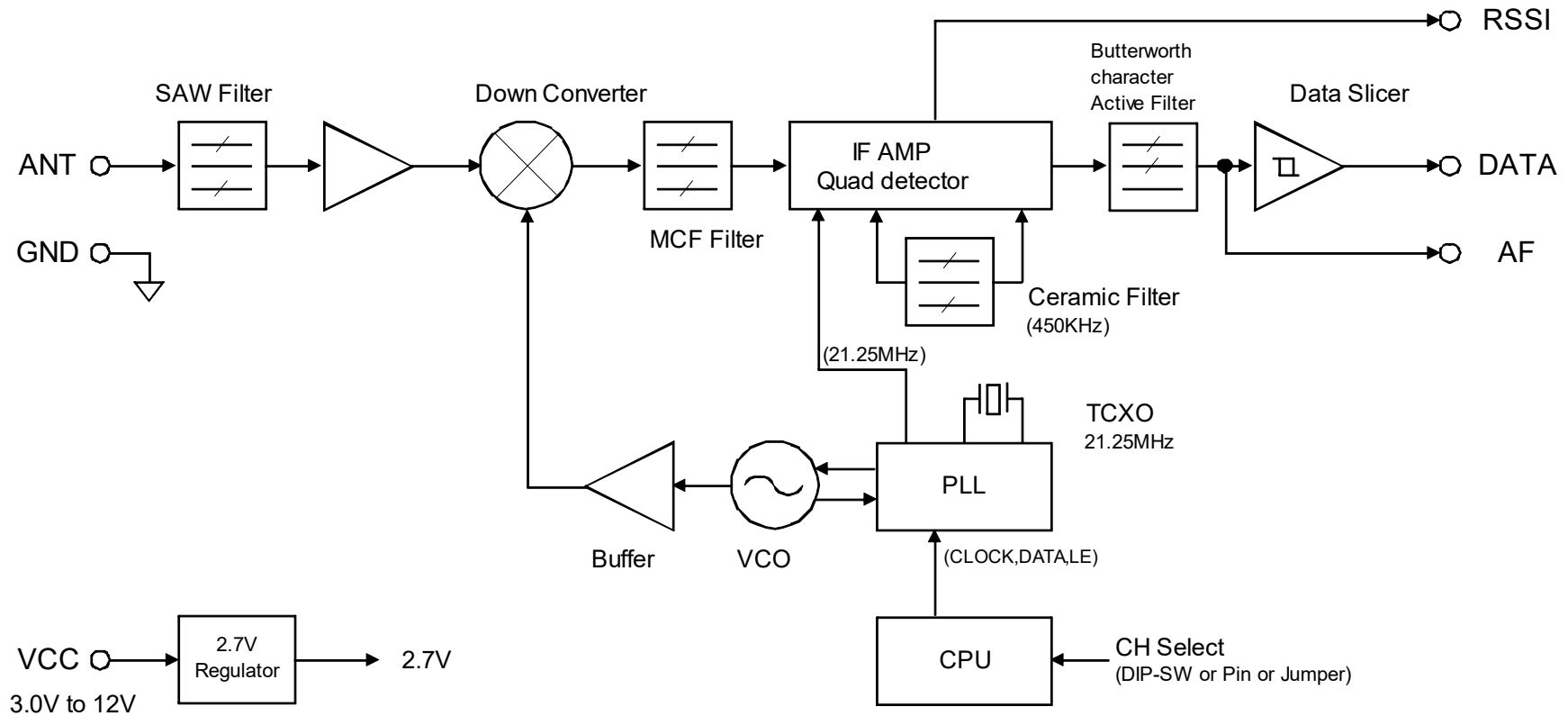

Dimensions

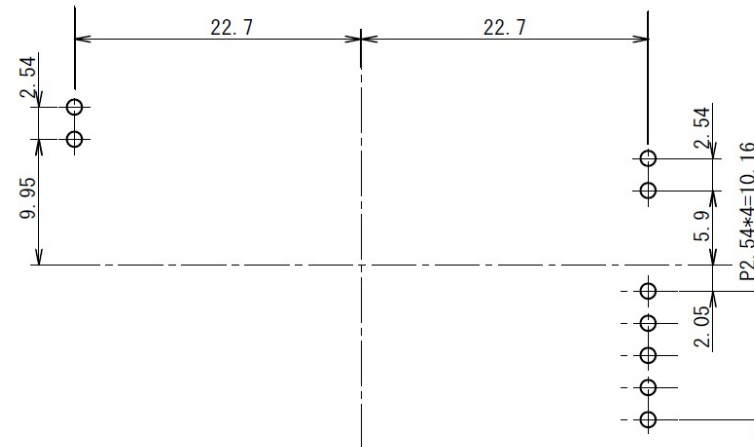
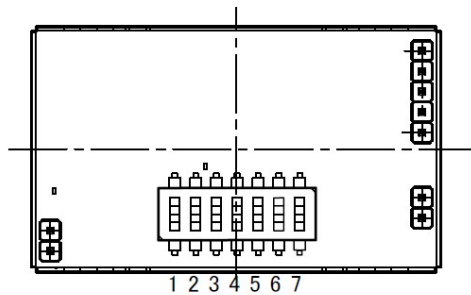
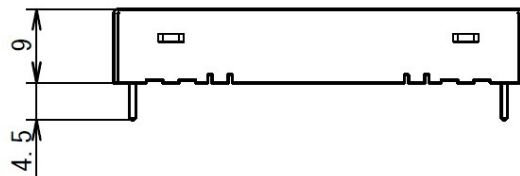
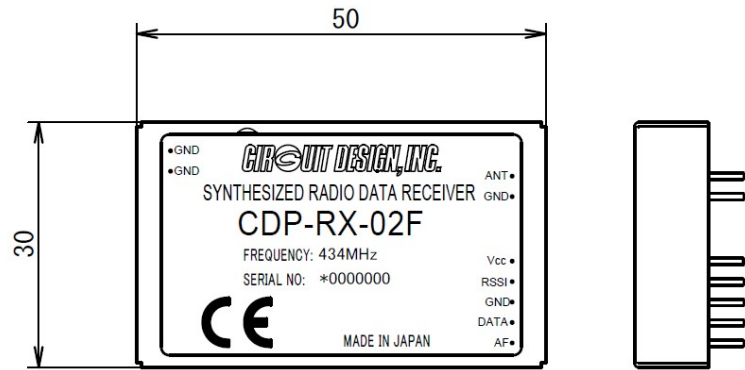

Reference hole position for PCB mounting (Top view)

Test data

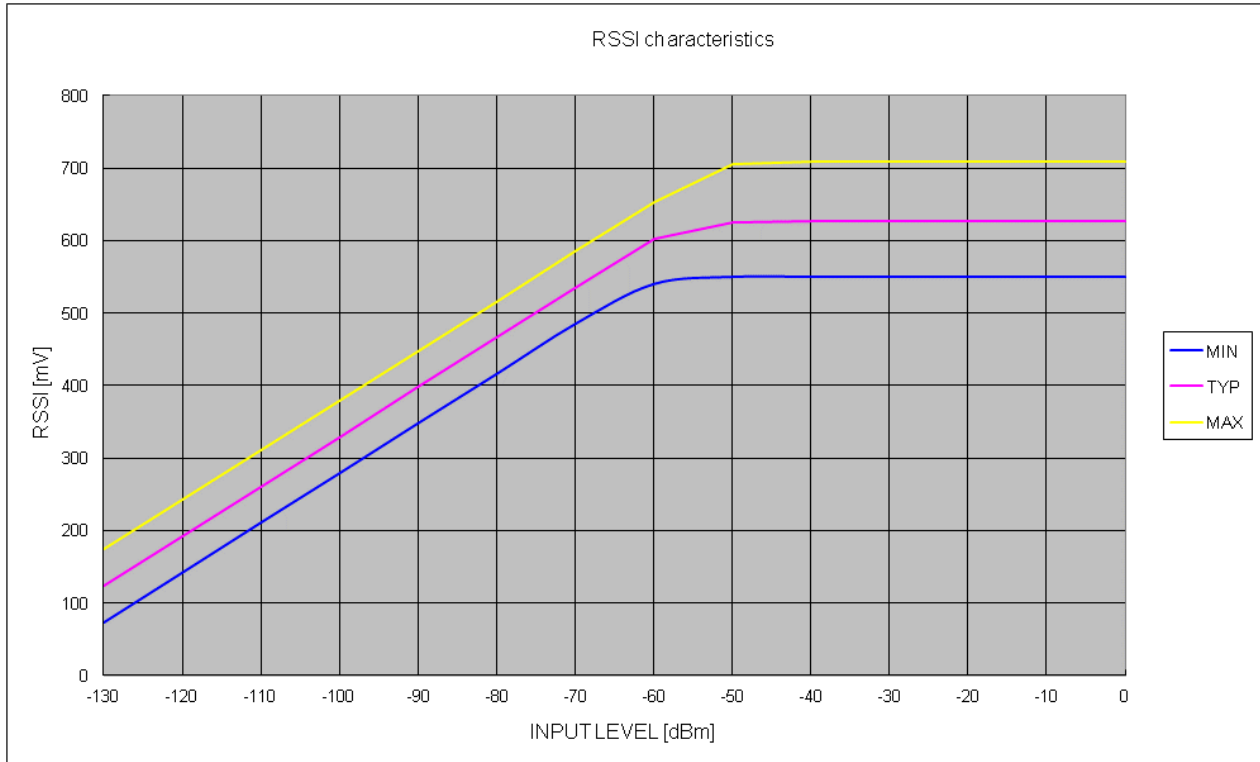

Regulatory compliance information

Declaration of Conformity

Hereby, Circuit Design, Inc. declares that the CDP-RX-02F is in compliance with RE Directive (2014/53/EU).

The full text of the EU Declaration of Conformity is available at www.circuitdesign.jp.

Cautions related to regulatory compliance when embedding the CDP-RX-02F

This product requires electrical and radio knowledge for setup and operation.

Supply voltage

To fulfill the safety requirements, the CDP-RX-02F should be connected to a proper power supply within the specified voltage range.

Enclosure

To fulfill the requirements of EMC and safety requirements, the CDP-RX-02F should be mounted on the circuit board of the final product and must be enclosed in the case of the final product. No surface of the module should be exposed.

Conformity assessment of the final product

The manufacturer of the final system needs to conduct full EMC testing in the final configuration and also ensure the final product fulfills the health and safety requirements and is also responsible for the conformity assessment procedures of the final product in accordance with the RE Directive.

Important notice

- Customers are advised to consult with Circuit Design sales representatives before ordering. Circuit Design believes the provided information is accurate and reliable. However, Circuit Design reserves the right to make changes to this product without notice.
- Circuit Design products are neither designed nor intended for use in life support applications where malfunction can reasonably be expected to result in significant personal injury to the user. Any use of Circuit Design products in such safety-critical applications is understood to be fully at the risk of the customer and the customer must fully indemnify Circuit Design, Inc for any damages resulting from any improper use.
- As the radio module communicates using electronic radio waves, there are cases where transmission will be temporarily cut off due to the surrounding environment and method of usage. The manufacturer is exempt from all responsibility relating to resulting harm to personnel or equipment and other secondary damage.
- The manufacturer is exempt from all responsibility relating to secondary damage resulting from the operation, performance and reliability of equipment connected to the radio module.

Copyright

- All rights in this operation guide are owned by Circuit Design, Inc. No part of this document may be copied or distributed in part or in whole without the prior written consent of Circuit Design, Inc.

Cautions

- Do not use the equipment within the vicinity of devices that may malfunction as a result of electronic radio waves from the radio module.
- Communication performance will be affected by the surrounding environment, so communication tests should be carried out before actual use.
- Ensure that the power supply for the radio module is within the specified rating. Short circuits and reverse connections may result in overheating and damage and must be avoided at all costs.
- Ensure that the power supply has been switched off before attempting any wiring work.
- The case is connected to the GND terminal of the internal circuit, so do not make contact between the '+' side of the power supply terminal and the case.
- When batteries are used as the power source, avoid short circuits, recharging, dismantling, and pressure. Failure to observe this caution may result in the outbreak of fire, overheating and damage to the equipment. Remove the batteries when the equipment is not to be used for a long period of time. Failure to observe this caution may result in battery leaks and damage to the equipment.
- Do not use this equipment in vehicles with the windows closed, in locations where it is subject to direct sunlight, or in locations with extremely high humidity.
- The radio module is neither waterproof nor splash proof. Ensure that it is not splashed with soot or water. Do not use the equipment if water or other foreign matter has entered the case.
- Do not drop the radio module or otherwise subject it to strong shocks.
- Do not subject the equipment to condensation (including moving it from cold locations to locations with a significant increase in temperature.)
- Do not use the equipment in locations where it is likely to be affected by acid, alkalis, organic agents or corrosive gas.
- Do not bend or break the antenna. Metallic objects placed in the vicinity of the antenna will have a great effect on communication performance. As far as possible, ensure that the equipment is placed well away from metallic objects.
- The GND for the radio module will also affect communication performance. If possible, ensure that the case GND and the circuit GND are connected to a large GND pattern.

Warnings

- Do not take a part or modify the equipment.
- Do not remove the product label (the label attached to the upper surface of the module.) Using a module from which the label has been removed is prohibited.

Copyright 2020, Circuit Design, Inc.

Revision history

Version	Date	Description	Remark
1.0	June 2020	The first issue	